

INSTRUCTION SHEET

811C-651

Cinch Table

Ready to show your home some love? Be sure to check all packing material carefully for small parts that may have come loose inside the carton during shipment.

Caution: (1) These parts are cumbersome and heavy. This product can best be assembled with the assistance of one or more persons in order to prevent personal injury and to insure parts are not damaged during the assembly process. If dirty, clean finished parts with mild dishwashing liquid and water solution applied on damp cloth. Cloth should not be excessively wet. Polish finish with soft cloth and an industry recognized furniture polish.

(2) To prevent damage to your floor or carpet, please check the bottom of each piece of furniture for stain residue and rough surfaces and also check for staples or nails left after removing the packaging material. The manufacturer will not be held responsible if preventative steps are not taken prior to installation.

(3) Unpack and dispose of all packing material but be careful not to throw away any assembly parts or hardware. Read the instruction sheet and parts list carefully. Remove all staples and screws used for packaging carefully using pliers and or screwdrivers to prevent injury and scratching or damaging flooring.

(4) During normal use everyday, screws, bolts, nuts and wooden plugs may loosen up. They should be periodically inspected and re-tightened to prevent damage to the furniture and (or) personal property or cause injury. Always check to be sure all hardware on this list and the above mentioned components is attached to the furniture properly and kept tightened at all times.

PARTS LIST:

#	Description	Qty.	#	Description	Qty.
A	Table Top	1pc	B	Post	4pcs
C	Metal Cap	1pc	D	Base	1pc
E	Hardware Pack	1bag			

Assembly Procedure: (Please follow the sketches below.)





Step 1: Unpack, inspect, and read assembly instruction carefully. Lay out the parts and hardware. Make sure the quantity of each is correct.

Step 2: Put all parts on a soft and smooth surface to avoid damage or being scratched. Attach the posts (B) to the bottom of table top (A) with phillip head bolts (2), spring washers (3) and flat washers (4) using wrench (1). Do not tighten all the bolts.

Step 3: Attach the metal cap (C) to the posts (B) with allen head bolts (5) using allen wrench (6).

Step 4: Connect the base (D) to the posts (B) with allen head bolts (6) using allen wrench (5). Tighten all the bolts and turn it upright.

Assembly is now complete.

HARDWARE LIST(E)			Q'TY
1	WRENCH	 87*19*2.5mmT	1PC
2	PHILLIP HEAD BOLT	 5/16"*7/8"	8PCS
3	SPRING WASHER	 5/16"*13*2mm	8PCS
4	FLAT WASHER	 5/16"*19*2mm	8PCS
5	ALLEN WRENCH	 70*30*4mm	1PC
6	ALLEN HEAD BOLT	 1/4"*1/2"	8PCS

INSTRUCTION SHEET

811C-651

Cinch Table

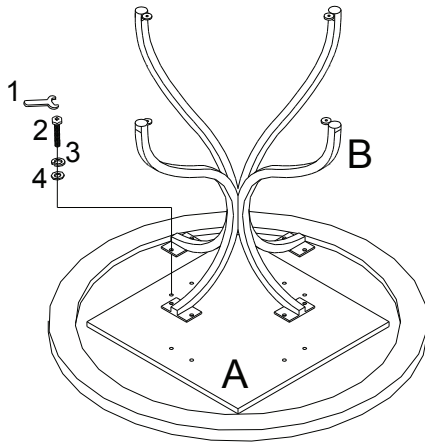

Step 2

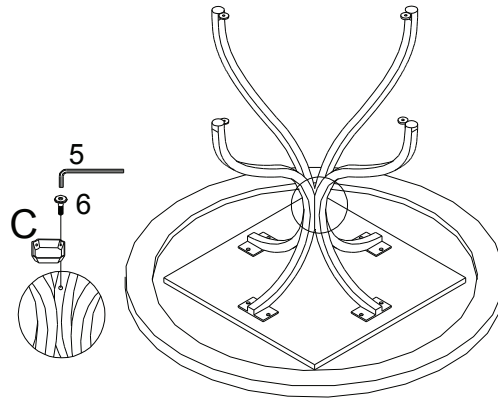

Step 3

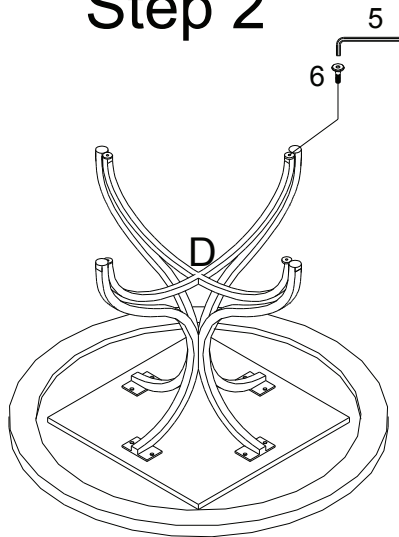

Step 4

